

The LEGO logo is displayed in its characteristic white font on a red rectangular background.

BIONICLE®

70793



LEGO.com/bionicle





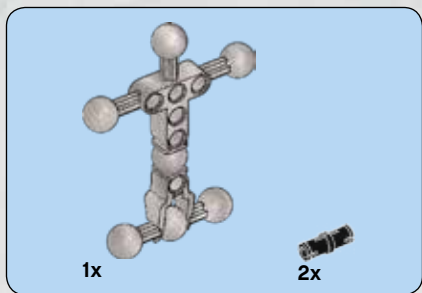

1

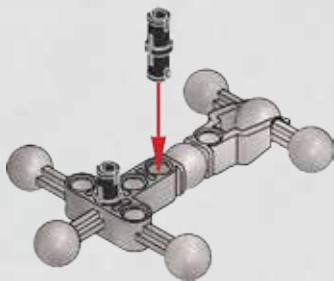

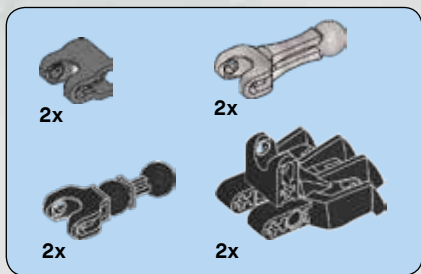

2

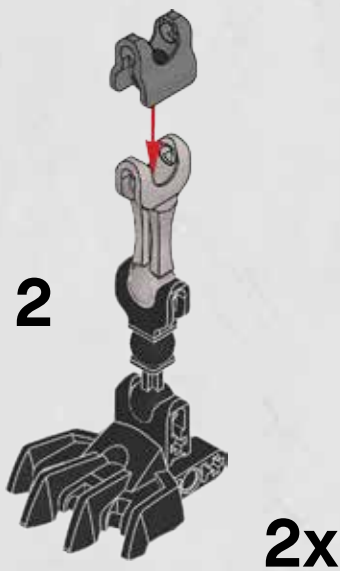
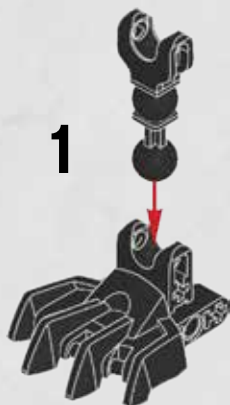

3

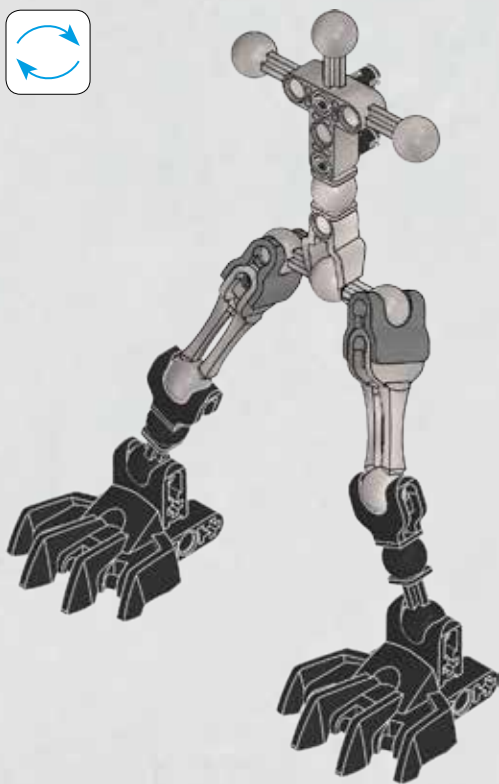

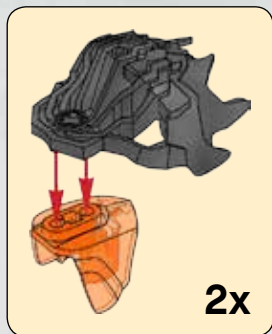
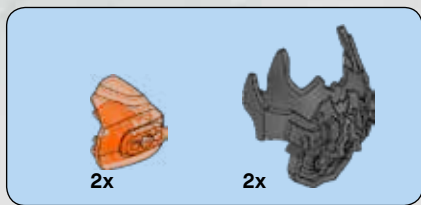

4

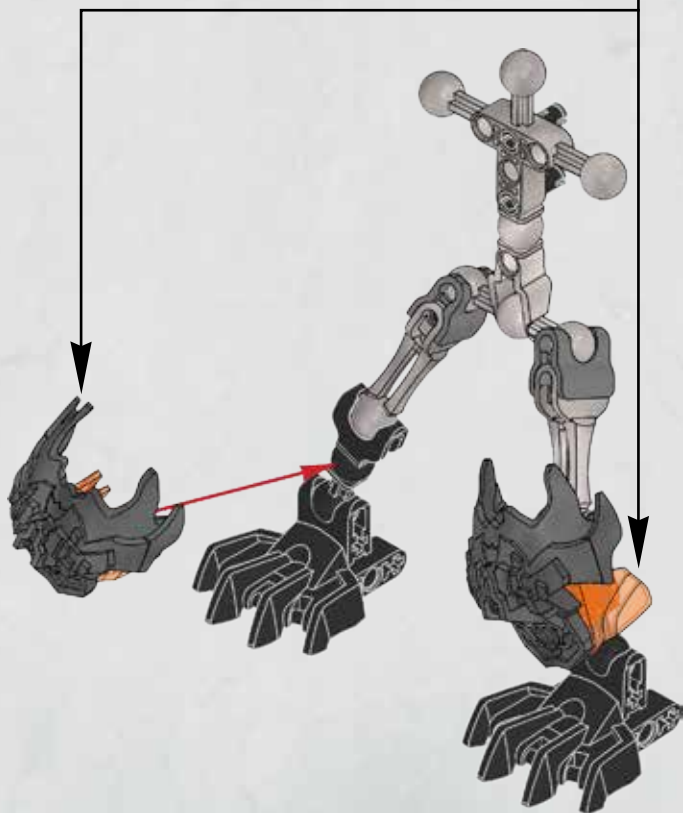

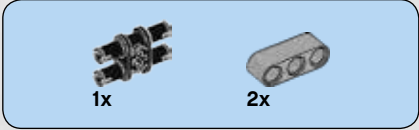

5

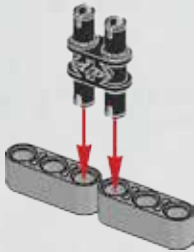

6

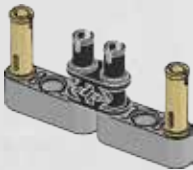



2x

7

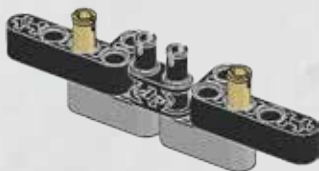

2x

8

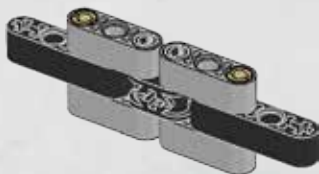

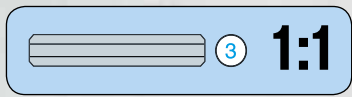
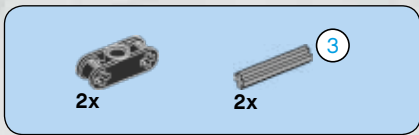

9

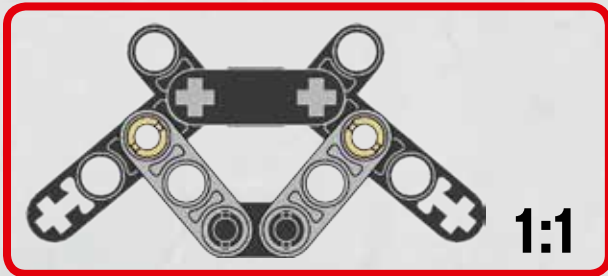
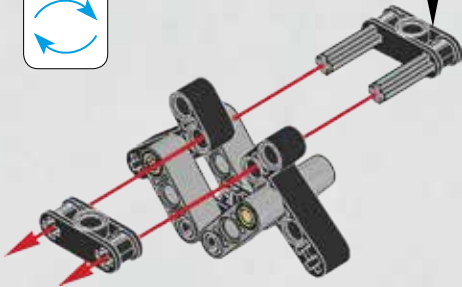
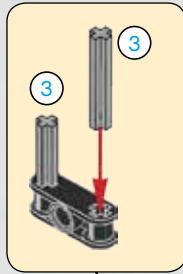

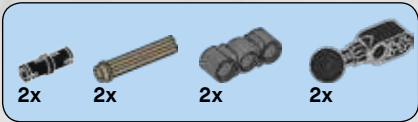

10

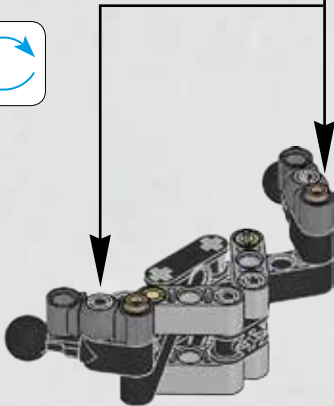
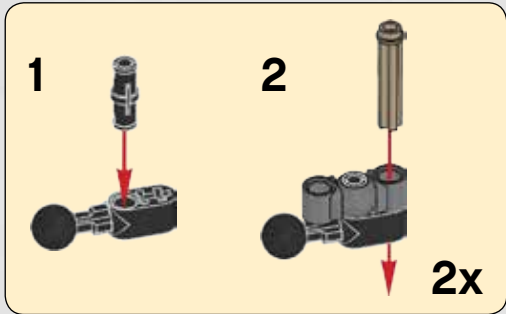

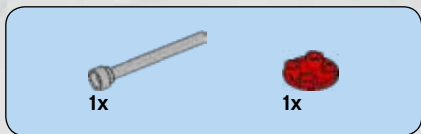

11

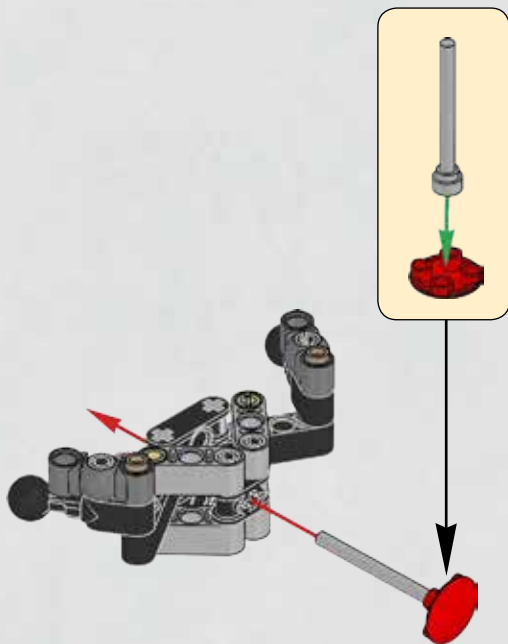



1x

12

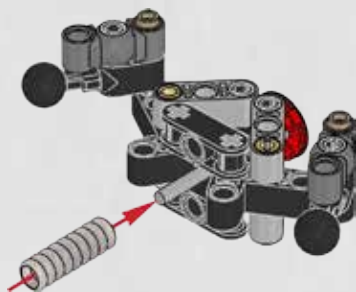

13



14

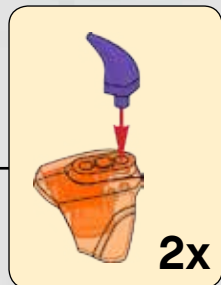

14

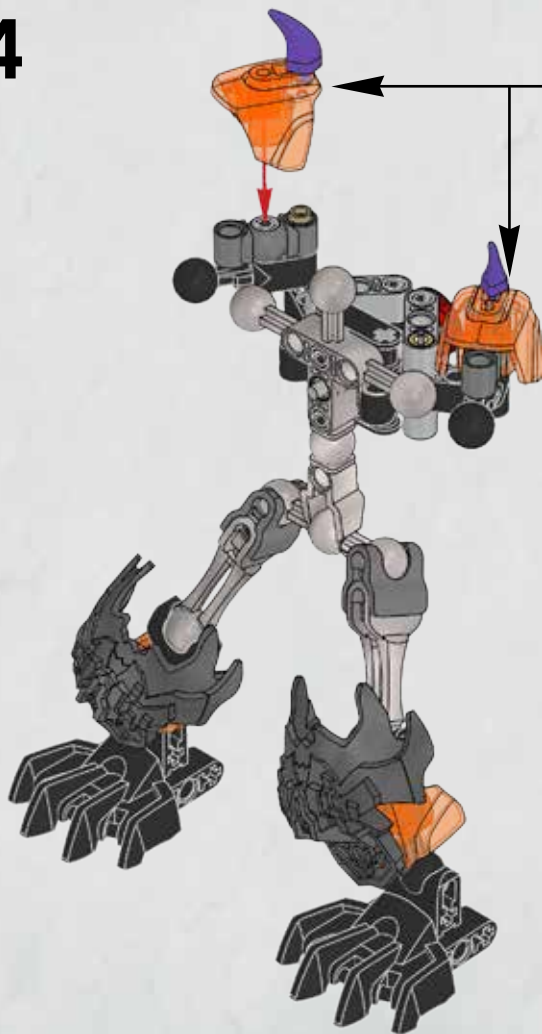



15

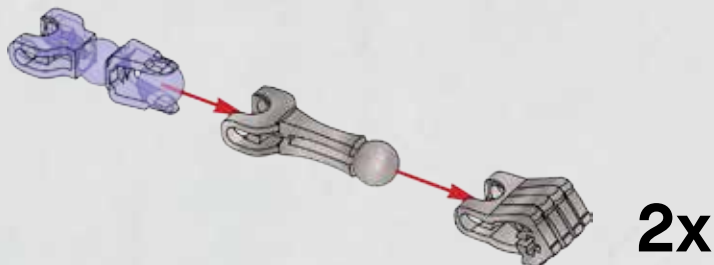

16



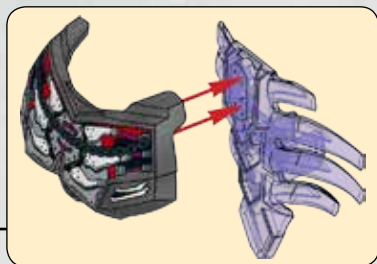

17



18

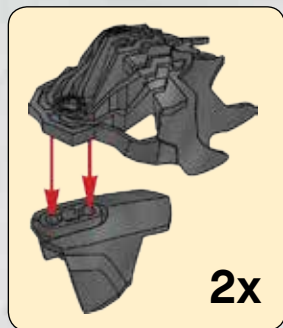
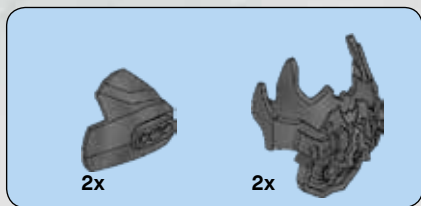

18

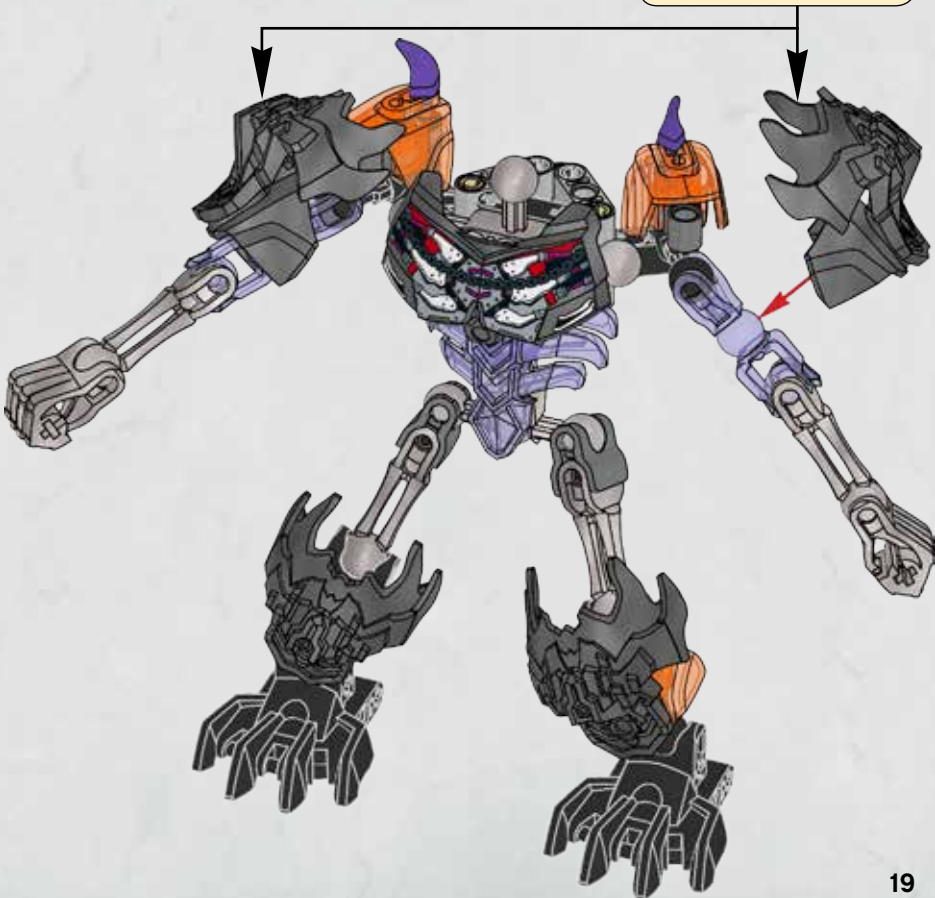



19



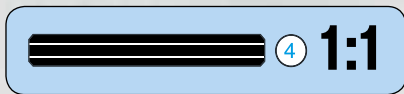
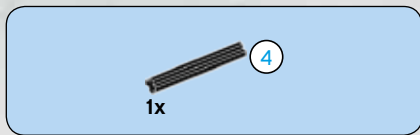

20

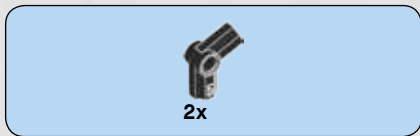
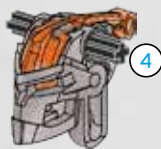

21

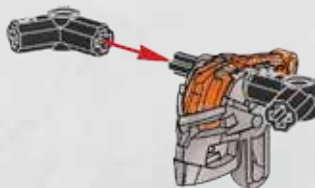



2x

22

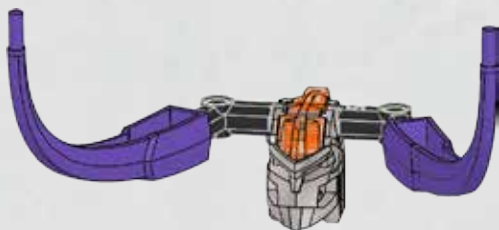

23



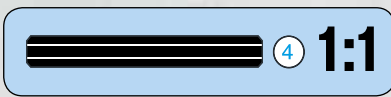
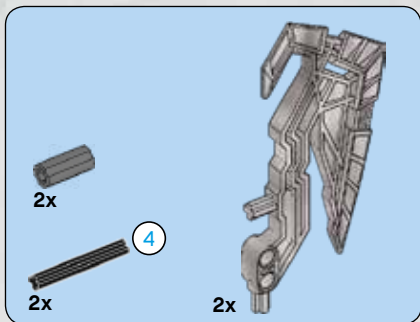

24

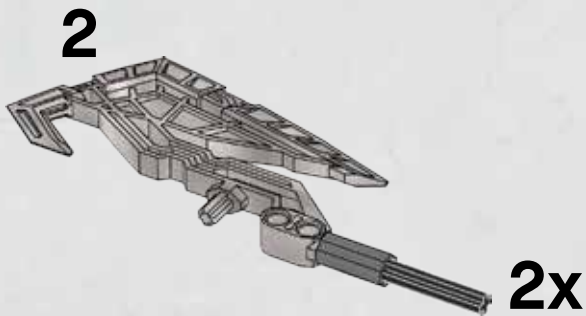
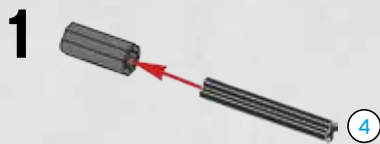

25



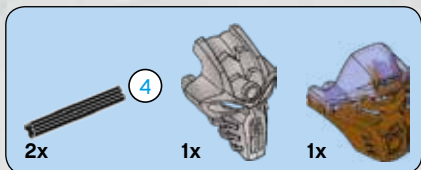

26

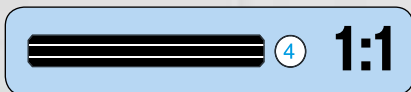
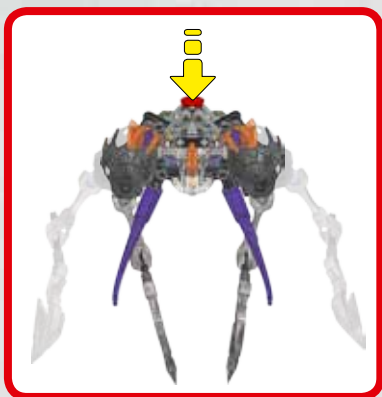

2x
4514554

1x
6116017

2x
6106472

1x
6102606

1x
4278275

1x
6102640

2x
6001085

2x
6114372

2x
4120017

4x
6045953

2x
4516546

2x
6114372

2x
4121667

2x
6102836

2x
6096663

2x
6061054

2x
4560108

1x
6114323

1x
6114369

1x
6115529

2x
4593555

2x
6031821

4x
6114326

4x
6114328

2x
6056379

1x
4211473

1x
6115891

2x
6114461

4x
4121715

1x
4211473

1x
6115891

4x
6114328

2x
4107084

4x
4211655

2x
4619077

2x
6114461

1x
4119589

2x
4211815

5x
370526



Customer Service

Kundenservice

Service Consommateurs

Servicio Al Consumidor

LEGO.com/service or dial



: 00800 5346 5555

: 1-800-422-5346



70791



70792



70793



LEGO.com/bionicle/bi

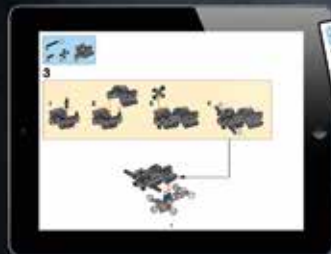

LEGO.com/bionicle



Download App
Télécharger l'application
Descarga la App



Available on the
 App Store

Apple, the Apple logo, iPad, iPhone and iPod touch are trademarks of Apple Inc.
Apple, le logo Apple, iPad, iPhone et iPod touch sont des marques de commerce d'Apple Inc.
Apple, el logotipo de Apple, iPad, iPhone e iPod touch son marcas comerciales de Apple Inc.

GET IT ON
 Google play

Google Play is a trademark of Google Inc.
Google Play est une marque de commerce de Google Inc.
Google Play es una marca comercial de Google Inc.





70791

70794



70795



70792



70793

WIN

GO TO WWW.LEGO.COM/PRODUCTFEEDBACK
AND GIVE US YOUR SHORT **FEEDBACK**
ABOUT THIS LEGO® SET FOR A CHANCE
TO WIN A COOL LEGO PRIZE.



LEGO.com/productfeedback

GEWINNE



Erzähle uns auf
www.LEGO.com/productfeedback

etwas über die Erfahrungen, die
du mit diesem LEGO® Set gemacht
hast, und sichere dir die Chance
auf einen coolen LEGO Preis!

GAGNE



Rends-toi sur
www.LEGO.com/productfeedback

et donne-nous quelques com-
mentaires sur ce produit LEGO®
pour avoir une chance de gagner
un prix LEGO !

GANA



Visita
www.LEGO.com/productfeedback

y envíanos tu opinión acerca de
este set LEGO®. ¡Participarás en el
sorteo de un premio LEGO!

获取奖品



登录
www.LEGO.com/productfeedback

给出关于此乐高®套装的简短反馈，
就有机会获得炫酷乐高®奖品

경품 당첨 기회



www.LEGO.com/productfeedback

페이지로 이동하여 이 레고® 세트에
대한 간단한 피드백을 보내 주시고
멋진 레고 경품을 탈 수 있는 기회도
잡으십시오

ЗАПОЛНИ АНКЕТУ И ПОЛУЧИ ПРИЗ



Перейди по ссылке
www.LEGO.com/productfeedback

ответь всего на несколько во-
просов об этом наборе LEGO®,
и у тебя появится шанс выиграть
замечательный приз от компа-
нии LEGO.

LEGO, the LEGO logo and BIONICLE are trademarks of the/son des marques de commerce du/
son marcas registradas de LEGO Group. ©2015 The LEGO Group.

6123866